

MADE IN TURKEY

PVC Trunking Cable Tray Systems

L Shaped Corner

Socket Sets

Internal Corner

External Corner

Partition

Modular System Cable Trunkings

PVC Trunking

Floor Type Cable Trunking

Slotted Cable Trunking

T Shaped Corner

PVC Trunking

Plastik Kablo Kanalları - Пластиковые короба

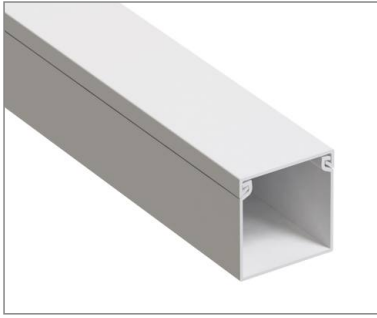

OT...						
CODE	SIZE	Length	PACKAGING TYPE	IN PACK QUANTITY	VOLUME OF PACK	WEIGHT OF PACK
	EBAT	UZUNLUK	PAKETLEME TIPI	PAKET İÇİ	KOLİ HACMİ	KOLİ AĞIRLIĞI
	mm	mm		m	m ³	kg
OT 1212	12x12	2000	in box	378	0,067	20,8
OT 1510	15x10	2000	in box	320	0,067	18,8
OT 1616	16x16	2000	in box	266	0,091	20,8
OT 2010	20x10	2000	in box	264	0,067	20,8
OT 2516	25x16	2000	in box	168	0,091	20,1
OT 2525	25x25	2000	in box	130	0,100	19,8
OT 3020	30x20	2000	in box	120	0,091	18,4
OT 4016	40x16	2000	in box	112	0,091	20,2
OT 4025	40x25	2000	in box	80	0,100	16,8
OT 4040	40x40	2000	in box	72	0,091	20,1
OT 6040	60x40	2000	in box	48	0,091	18,4
OT 6060	60x60	2000	in box	40	0,100	20,8
OT 8040	80x40	2000	in box	36	0,091	18,9
OT 8060	80x60	2000	in box	32	0,100	21,0
OT 10040	100x40	2000	in box	28	0,091	20,1
OT 10060	100x60	2000	in box	24	0,100	20,1
OT 12060	120x60	2000	in box	20	0,100	20,9

Adhesive PVC Trunking

Yarışkan Bantlı Plastik Kablo Kanalı - Пластиковые короба (с клейкой изолирующей лентой)

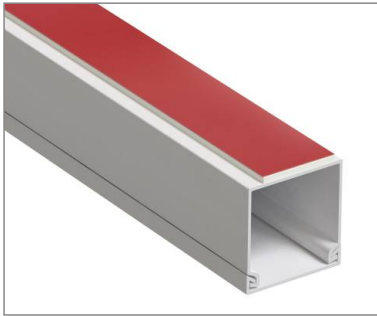

AOT...						
CODE	SIZE	Length	PACKAGING TYPE	IN PACK QUANTITY	VOLUME OF PACK	WEIGHT OF PACK
	EBAT	UZUNLUK	PAKETLEME TIPI	PAKET İÇİ	KOLİ HACMİ	KOLİ AĞIRLIĞI
	mm	mm		m	m ³	kg
AOT 1212	12x12	2000	in box	360	0,067	21,3
AOT 1510	15x10	2000	in box	320	0,067	19,4
AOT 1616	16x16	2000	in box	266	0,091	21,3
AOT 2010	20x10	2000	in box	240	0,067	21,3
AOT 2516	25x16	2000	in box	168	0,091	20,7
AOT 2525	25x25	2000	in box	130	0,100	20,3
AOT 3020	30x20	2000	in box	120	0,091	18,9
AOT 4016	40x16	2000	in box	112	0,091	20,8
AOT 4025	40x25	2000	in box	80	0,100	17,2
AOT 4040	40x40	2000	in box	72	0,091	20,5
AOT 6040	60x40	2000	in box	48	0,091	18,9
AOT 6060	60x60	2000	in box	40	0,100	21,2

OT...

General features

Raw Material PVC UL94, V0 M1

Impact Resistance : 2 Joule
Operation Temperature : -25 +65 Co

Colour : White RAL 9010
IP Ingress Protection : IP40

Additional Features

UV resistant
Easy Install, pantable, non-flammable, Economic and adaptable
Resistant to acids, oils and greases Non-conduct ve
Nonflammable

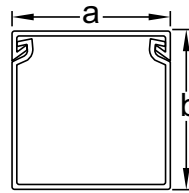

Important:

The label size area of our cable trunking without adhesive tape is GRAY on the box.

AOT...

General features

Raw Material PVC UL94, V0 M1

Impact Resistance : 2 Joule
Operation Temperature : -25 +65 Co

Colour : White RAL 9010
IP Ingress Protection : IP40

Additional Features

UV resistant
Easy Install, pantable, non-flammable, Economic and adaptable
Resistant to acids, oils and greases Non-conduct ve
Nonflammable

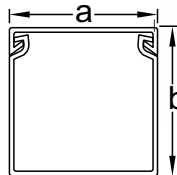

Important:

The label size area of our cable trunking with adhesive tape is RED or YELLOW for self adhesive ones.

Modular Sistem Kablo Kanalları

Inside covered cable trunkings - Кабель-канал пластиковый с крышкой

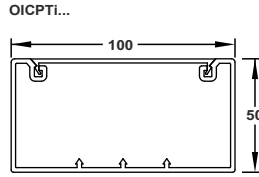

CODE	SIZE EBAT	LENGTH UZUNLUK (L)	PACKAGING TYPE	IN PACK QUANTITY (PAKET İÇİ)	VOLUME OF PACK KOLI HACMI	WEIGHT OF PACK KOLI AĞIRLIĞI
	mm	mm		m	m3	kg
OICPT 10050	100x50	2000	in box	16	0,067	16,9
OICPT 10050.29	100x50	2900	in nylon bag	23,2	0,098	24,1

Accessories

Aksesuarlar - Аксессуары

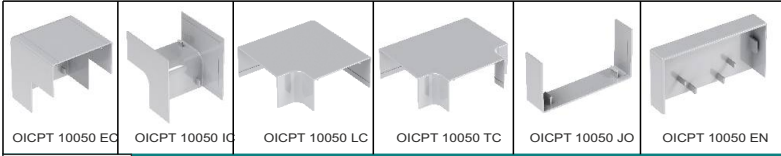

CODE	DESCRIPTION OF GOODS		SIZE EBAT	IN PACK QUANTITY KOLI İÇİ ADET	VOLUME OF PACK KOLI HACMI	WEIGHT OF PACK KOLI AĞIRLIĞI
	EN	TR				
	mm	m/pc	m3	kg		
OICPT 10050 SE	Part t on	Ara bölme	100x50	150 m	0,075	19,6
OICPT 10050 EC	External Corner	Dış köşe	100x50	8 pc	0,0094	0,9
OICPT 10050 IC	Internal Corner	İç Köşe	100x50	8 pc	0,0100	0,6
OICPT 10050 LC	L Shaped Corner	L Dirsek	100x50	10 pc	0,0136	1,0
OICPT 10050 TC	T Shaped Corner	T Dirsek	100x50	10 pc	0,0136	1,0
OICPT 10050 JO	Joint	Birleştirme Elemanı	100x50	100 pc	0,0100	1,6
OICPT 10050 EN	Ending	Sonlandırma Kapağı	100x50	40 pc	0,0040	0,7

Socket Sets

Priz Montaj Seti - Рамка-суппорт

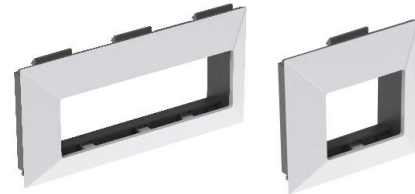

PS...

CODE	DESCRIPTION OF GOODS		FOR SOCKET SIZE	IN PACK QUANTITY PAKET İÇİ	VOLUME OF PACK KOLI HACMI	WEIGHT OF PACK KOLI AĞIRLIĞI
	EN	TR				
mm	pc	m3	kg			
OPS 11	Single Frame	Tekli Çerçeve	45x45	20	0,006	1,12
OPS 12	Double Frame	İkili Çerçeve	45x45	14	0,006	1,07
OPS 13	Triple Frame	Üçlü Çerçeve	45x45	12	0,006	1,08
OPS 14	Quartet Frame	Dörtlü Çerçeve	45x45	10	0,006	1,18

Socket Sets (British Norm)

Priz Montaj Seti (İngiliz normu) - Рамка-суппорт (Английский Стандарт)



PSI...

CODE	DESCRIPTION OF GOODS		FOR SOCKET SIZE	IN PACK QUANTITY PAKET İÇİ	VOLUME OF PACK KOLI HACMI	WEIGHT OF PACK KOLI AĞIRLIĞI
	EN	TR				
mm	pc	m3	kg			
OPSI 15	Single Socket Base	Priz Tabanı (Tek)	SNG BS	200	0,040	3,85
OPSI 16	Double Socket Base	Priz Tabanı (Çift)	DBL BS	100	0,040	2,48
OPSI 17	Double High Socket Base	Priz Tabanı (Çiftli Yüksek)	2x SNG BS	94	0,032	5,07

ACCESSORIES (MOUNTING SAMPLES)

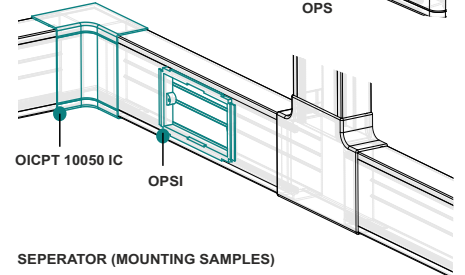
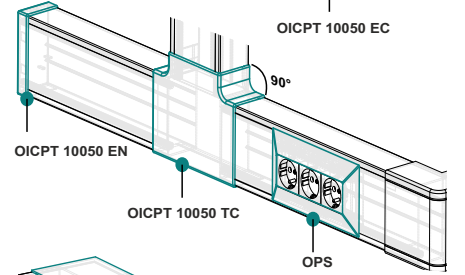
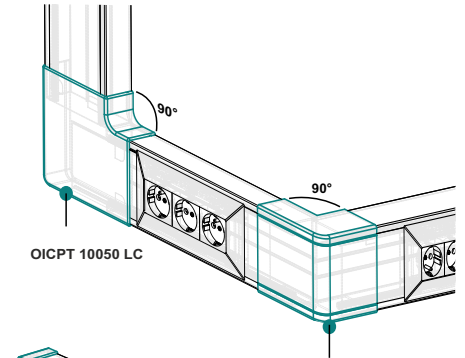

SEPERATOR (MOUNTING SAMPLES)

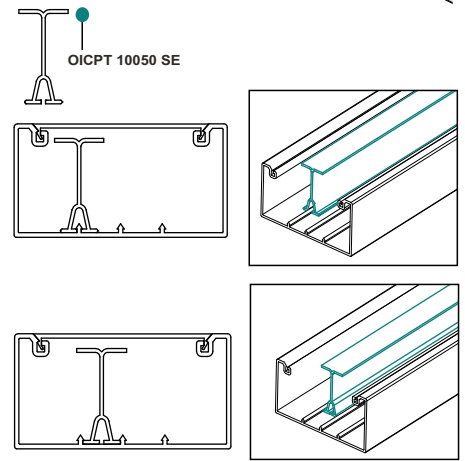

Technical Properties

Raw Material	PVC UL94, VO M1
Impact Resistance	2 Joule
Ip Rating	IP40
Colour	White RAL 9010
Temperature Resistance	-25 C / +65 C

Additional Features

- UV resistance
- Easy install, paintable
- Economic and adaptable
- Resistant to acids, oils and greases
- Non-conductive
- Non-flammable

Floor Type Cable Trunkings

Balık Sırtı PVC Kanal - Напольный канал



ODPT...						
CODE	SIZE	Length	PACKAGING TYPE	IN PACK QUANTITY	VOLUME OF PACK	WEIGHT OF PACK
	EBAT	UZUNLUK	PAKETLEME TIPI	KOLİ İÇİ	KOLİ HACMİ	KOLİ AĞIRLIĞI
	mm	mm		m	m ³	kg
ODPT 5012	50x12	2000	in box	60	0,040	23,40
ODPT 6015	60x15	2000	in box	40	0,040	14,60
ODPT 7520	75x20	2000	in box	30	0,040	19,20
ODPT 9020	90x20	2000	in box	20	0,040	16,60

Adhesive Type						
CODE	SIZE	Length	PACKAGING TYPE	IN PACK QUANTITY	VOLUME OF PACK	WEIGHT OF PACK
	EBAT	UZUNLUK	PAKETLEME TIPI	KOLİ İÇİ	KOLİ HACMİ	KOLİ AĞIRLIĞI
	mm	mm		m	m ³	kg
OADPT 5012	50x12	2000	in box	60	0,040	23,40
OADPT 6015	60x15	2000	in box	40	0,040	14,60
OADPT 7520	75x20	2000	in box	30	0,040	19,20
OADPT 9020	90x20	2000	in box	20	0,040	16,60

Slotted Cable Trunking

Pano Tipi PVC Kanal
Короб перфорированный

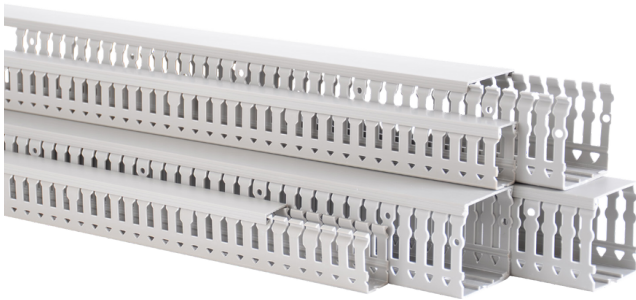

Product Code	Size & Description	Box Qty. / mt.
OCT2540G	25x40 Cable Trunking	100
OCT2560G	25x60 Cable Trunking	60
OCT2580G	25x80 Cable Trunking	56
OCT4040G	40x40 Cable Trunking	52
OCT4060G	40x60 Cable Trunking	36
OCT4080G	40x80 Cable Trunking	40
OCT4010G	40x100 Cable Trunking	28
OCT6040G	60x40 Cable Trunking	36
OCT6060G	60x60 Cable Trunking	24
OCT6080G	60x80 Cable Trunking	24
OCT6010G	60x100 Cable Trunking	36
OCT8040G	80x40 Cable Trunking	36
OCT8060G	80x60 Cable Trunking	28
OCT8080G	80x80 Cable Trunking	20
OCT8010G	80x100 Cable Trunking	24
OCT1060G	100x60 Cable Trunking	20
OCT1080G	100x80 Cable Trunking	16
OCT1010G	100x100 Cable Trunking	24

ODPT..
OADPT...

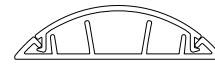

50X13

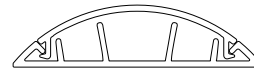

60X15

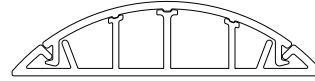

75X18

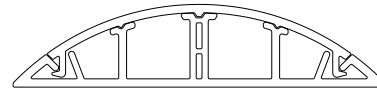

90X20

Technical Properties

Raw Material	PVC UL94, VO M1
Colour	RAL 9030 GREY
Temperature Resistance	-25 C / +60 C

Additional Features

- UV resistance
- Easy install, paintable
- Economic and adaptable
- Resistant to acids, oils and greases
- Non-conductive
- Non-flammable

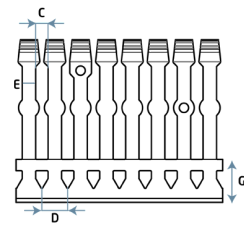
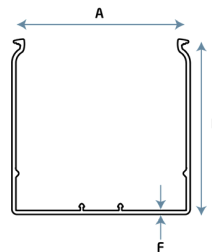

Technical Properties

Raw Material	PVC UL94, VO
Colour	RAL 9030 GREY
Temperature Resistance	-15 C / +60 C